

組立見本図

カラー：(S)シルバー (B)ブラック

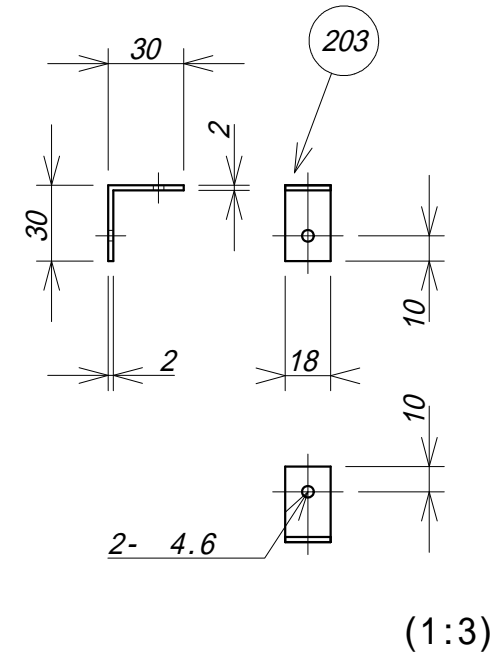
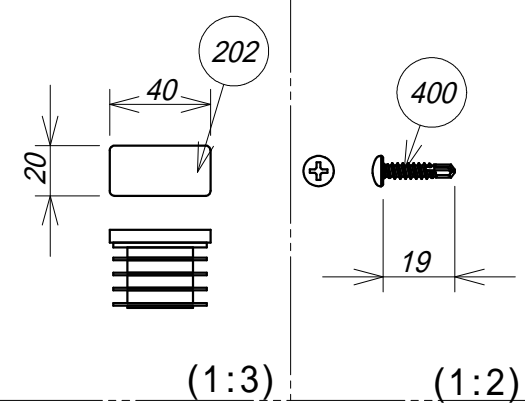
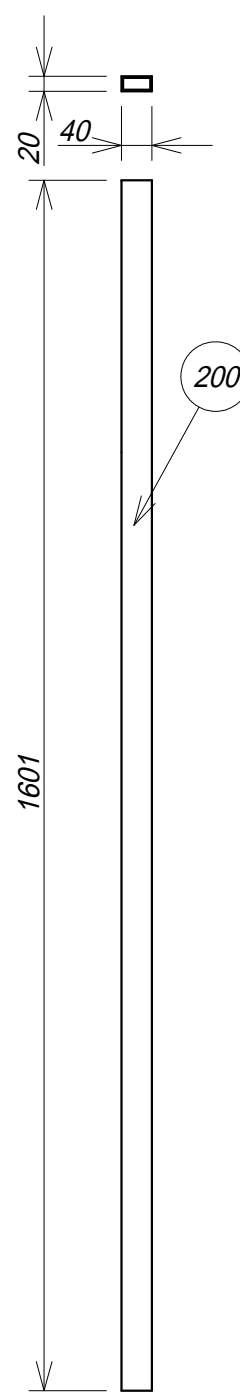
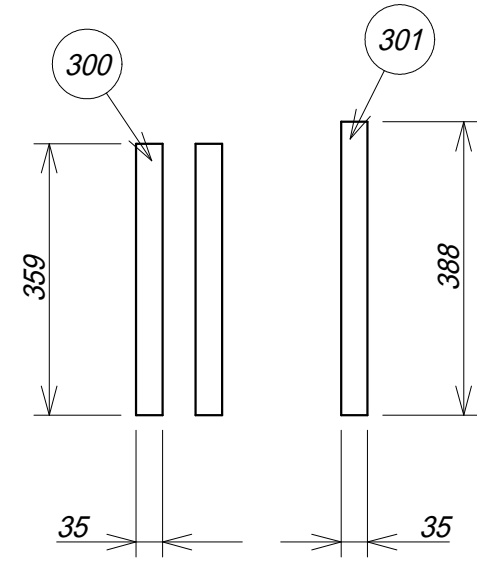
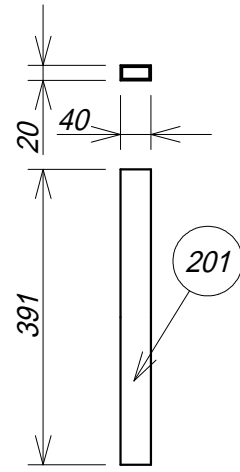
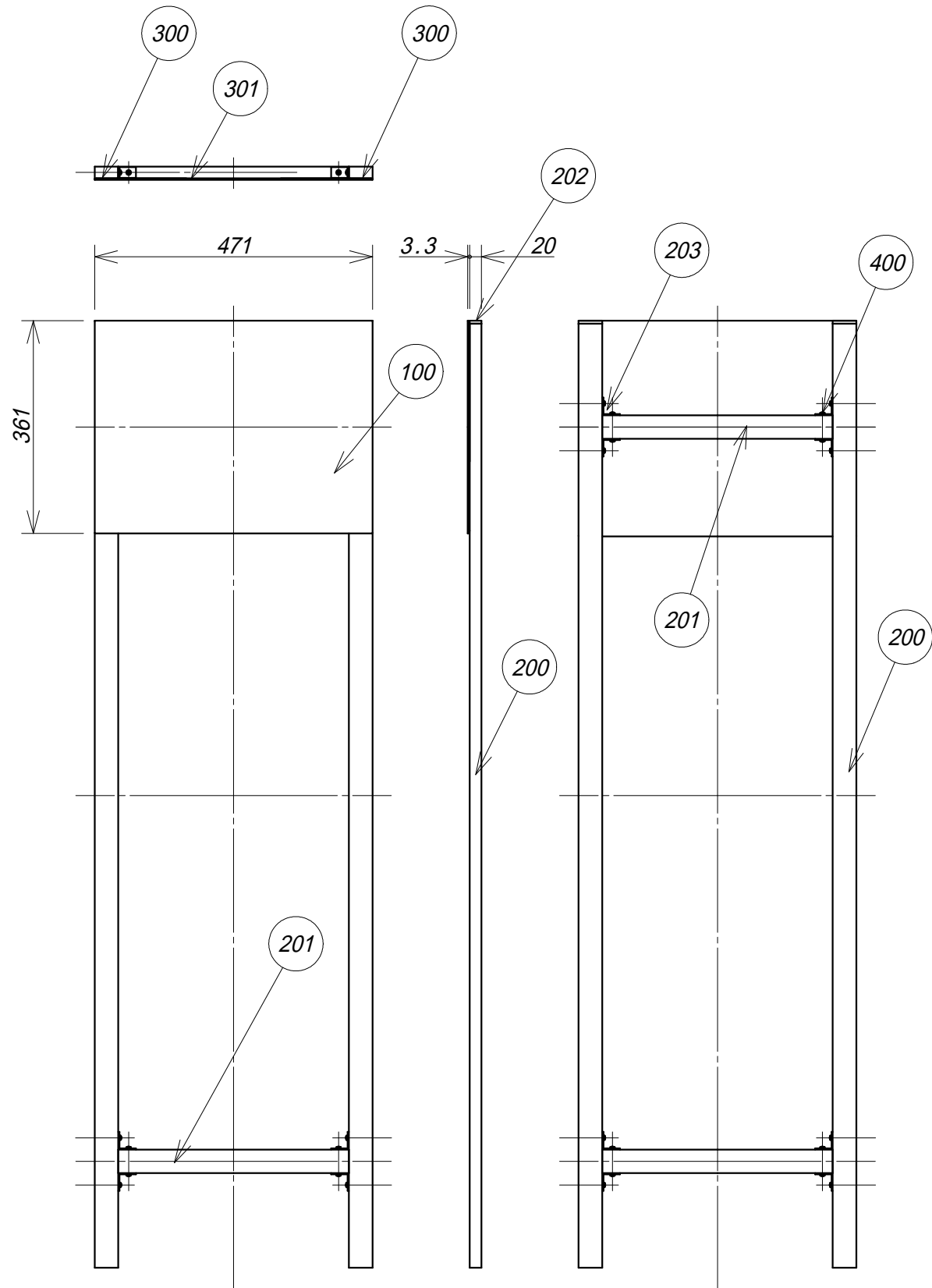

REV.	PART No.	PART NAME	MATERIAL	TYPE	Q'TY	REMARKS
	100	ミラー	PMMA AL		1	
	200	不等辺角パイプ	AL		2	
	201	不等辺角パイプ	AL		2	
	202	樹脂キャップ	PE		2	
	203	Lアングル	AL		8	
	300	両面テープ	アクリル系 接着剤	VHB4920	2	
	301	両面テープ	アクリル系 接着剤	VHB4920	1	
	400	4×19ドリルねじ	SUS		16	

TITLE FFミラー自立埋込タイプ				PROJECTION 	SCALE A3 1:10	DIM. mm
CUSTOMER	DWG. CHKD. APRD.	H. TAKEDA Y. IWATA T. NOMURA	Jan-13-21 Jan-13-21 Jan-13-21	ASS. WEIGHT Max0.7kg (mirror)	Komy® DRW. No. F48EX	
					REV. SYM. -	04